

Collimation of a Newtonian Reflector Telescope

What is Collimation?

Collimation is the process of adjusting the telescope's primary and secondary mirrors so they are aligned with one another and with the mechanical axis of the telescope. The primary mirror is the large mirror at the bottom end of the telescope tube. The secondary mirror is the smaller mirror near the front of the tube that deflects converging light from the primary mirror out through the focuser to the eyepiece (**Figure 1**). Accurate mirror alignment is important to ensure that the images produced by the telescope are as sharp and crisp as possible. And since the mirrors can go out of alignment occasionally due to jostling or temperature changes or even gravity, the alignment should be checked regularly.

Collimation is a relatively easy process and can be done in daylight or darkness. To do a quick visual check of the collimation, remove the eyepiece and look down the focuser drawtube, preferably with the aid of a quick-collimation cap (see below) or a Cheshire eyepiece. You should see the secondary mirror centered in the drawtube, as well as the reflection of the primary mirror centered in the secondary mirror, and the reflection of the secondary mirror (and your eye) centered in the reflection of the primary mirror, as in **Figure 2a**. If anything is significantly off-center, the optics need aligning and you should proceed with the following collimation procedure.

The Collimation Cap

Your Orion reflector telescope comes with a "quick collimation cap," shown in **Figure 3**. This is a simple cap that fits on the focuser drawtube like a dust cap, but has a tiny hole in the center. The collimation cap helps center your eye over the focuser drawtube, making it easier to align the optical components. The reflective surface on the cap's underside provides a distinct visual reference that is helpful in centering the mirror reflections. **Figures 2b through 2e** assume that you have the collimation cap in place.

Primary Mirror Center Mark

The primary mirror of your reflector telescope should have a tiny ring (sticker) marking its center. This "center mark" is helpful in achieving a precise collimation. **Do not remove it!** Because it lies directly in the shadow of the secondary mirror, its presence in no way adversely affects the optical performance of the telescope or the image quality. That might seem counterintuitive, but it's true!

Preparing the Telescope for Collimation

Once you get the hang of collimating, you will be able to do it quickly even in the dark. For now, it is best to collimate in daylight, preferably in a brightly lit room and aimed at a light-colored wall. It is recommended that the telescope tube be oriented horizontally. This will prevent any parts from the secondary mirror from falling down onto the primary mirror and causing damage if something comes loose while you are making adjustments. Place a small sheet of white paper inside the optical tube directly opposite the focuser (**Figure 4**). The paper will provide a bright "background" when viewing into the focuser.

Aligning the Secondary Mirror

To adjust the secondary mirror collimation, you will need to use the correct size of Allen key, which is often a 2mm or 2.5mm key. One may have been included with your telescope.

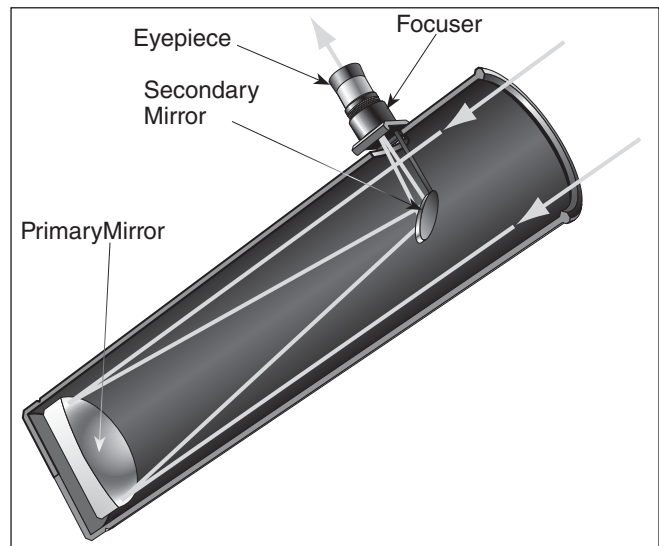

Figure 1. This diagram illustrates the Newtonian reflector's optical components. Aligning and centering these components is required for sharp, crisp images.



Corporate Offices: 89 Hangar Way, Watsonville CA 95076 - USA
Toll Free USA & Canada: (800) 447-1001
International: +1(831) 763-7000
Customer Support: support@telescope.com

Copyright © 2022 Orion Telescopes & Binoculars. All Rights Reserved. No part of this product instruction or any of its contents may be reproduced, copied, modified or adapted, without the prior written consent of Orion Telescopes & Binoculars.

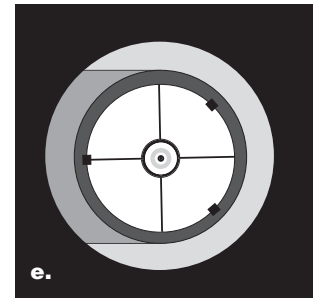
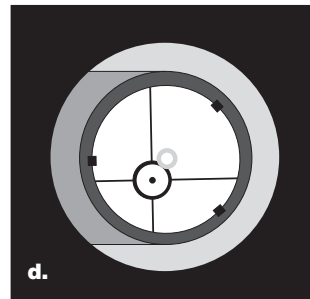
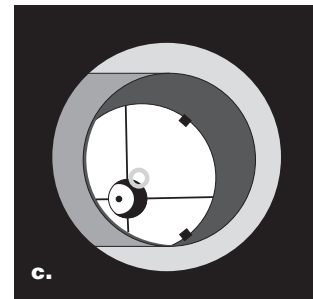
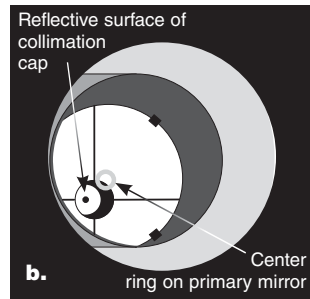
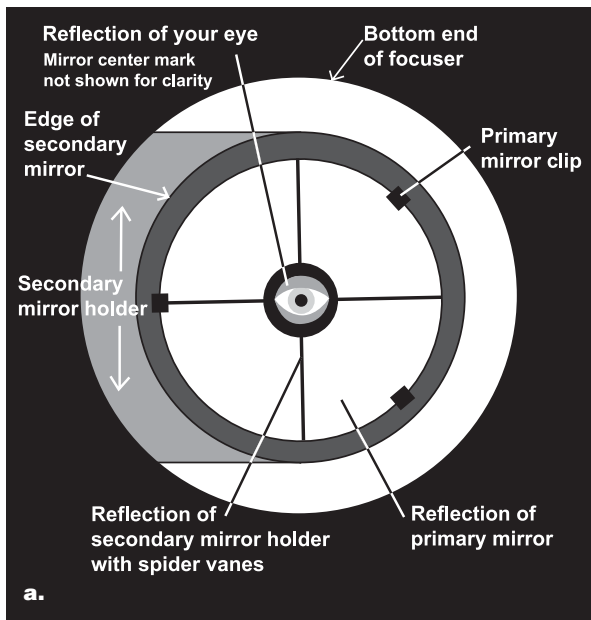

Figure 2. Collimating the optics. (a) When the mirrors are properly aligned, the view down the focuser drawtube should look like this. (b) With the collimation cap in place, if the optics are out of alignment, the view might look something like this. (c) Here, the secondary mirror is centered under the focuser, but it needs to be adjusted (tilted) so that the entire primary mirror is visible. (d) The secondary mirror is correctly aligned, but the primary mirror still needs adjustment. When the primary mirror is correctly aligned, the “dot” will be centered, as in (e).

There are two adjustments to the secondary mirror that you may have to make. The first is to center the secondary mirror in the circle formed by the focuser drawtube. This adjustment will rarely, if ever, need to be done. The second adjustment you’ll make is to the tilt of the secondary mirror, to make sure all the light from the primary mirror is properly reflected up through the focuser into the eyepiece. This is the more common secondary mirror adjustment.

Centering the Secondary Mirror in the Focuser Drawtube

Let’s start with the first adjustment – centering the secondary mirror in (actually, under) the focuser drawtube. With the collimation cap in place on the focuser collar, look through the hole in the collimation cap at the secondary (diagonal) mirror. Ignore the reflections for the time being. The secondary mirror itself should be centered in the circle of the focuser drawtube. If it is, as in **Figure 2c**, you can move on to the next section, *Adjusting the Secondary Mirror’s Tilt*. If it isn’t centered, as in **Figure 2b**, it must be adjusted as follows.

Using a 2mm hex key, loosen the three small alignment setscrews in the center hub of the 4-vaned spider several turns (**Figure 4**). Now hold the mirror holder stationary (be careful not to touch the surface of the mirror), while turning the center screw with a Phillips head screwdriver. Turning the screw clockwise will move the secondary mirror toward the front opening of the optical tube, while turning the screw counter-clockwise will move the secondary mirror toward the primary mirror.

When the secondary mirror is centered in the focuser drawtube, rotate the secondary mirror holder until the reflection of the primary mirror is as centered in the secondary mirror as possible. It may not be perfectly centered, but that is OK. Now tighten the three small alignment screws equally to secure the secondary mirror in that position. If the entire primary mirror reflection is not visible in the secondary mirror, as in **Figure 2c**, you will need to adjust the tilt of the secondary mirror.

Adjusting the Secondary Mirror’s Tilt

The goal with this adjustment is to center the primary mirror reflection in the secondary mirror, as in **Figure 2d**. Don’t worry that the reflection of the secondary mirror (the smallest circle, with the collimation cap “dot” in the center) is off-center. You will fix that in the next step. Using the 2mm hex key, first loosen one of the three alignment setscrews by no more than ¼ turn, then lightly tighten the other two to take up the slack (**Figure 4**). Is the primary mirror reflection more centered now? If not, then try loosening one of the other two setscrews. Always loosen one first, then tighten one or both of the other two setscrews. It will take some trial and error, but by adjusting the three setscrews a small amount at a time, you should be able eventually to see the whole primary mirror in the secondary mirror, just like in **Figure 2d**.

At the end of the procedure all three setscrews should be tight – but don’t overtighten! -- to ensure that the secondary mirror can’t move.

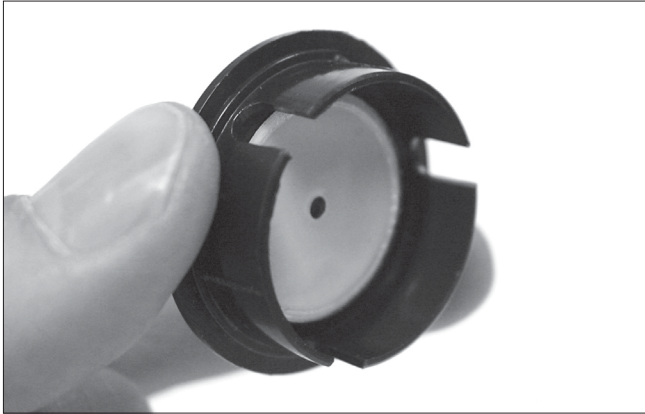

Figure 3. The quick collimation cap, which features a reflective surface on its underside, helps in centering reflections of the optics in the focuser during the collimation process.

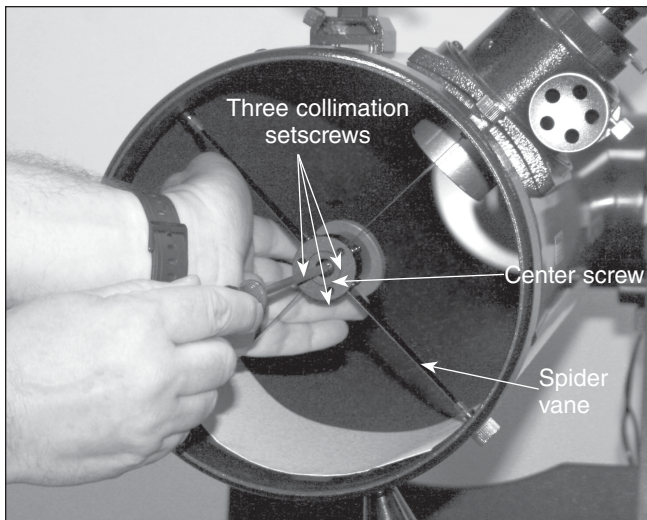

Figure 4. To center the secondary mirror under the focuser, hold the mirror holder in place with one hand while adjusting the center bolt with a Phillips screwdriver. Do not touch the mirror's surface! Adjust the tilt of the secondary mirror with the three collimation setscrews surrounding the center screw of the secondary mirror housing.

Aligning the Primary Mirror

The final adjustment is made to the primary mirror. It will need adjustment if, as in **Figure 2d**, the secondary mirror is centered under the focuser and the reflection of the primary mirror is centered in the secondary mirror, but the small reflection of the secondary mirror (with the “dot” of the collimation cap) is off-center.

The tilt of the primary mirror is adjusted with three spring-loaded collimation thumbscrews on the bottom end of the optical tube (**Figure 5**); these are usually the larger thumbscrews. The other three smaller thumbscrews lock the mirror's position in place; these locking thumbscrews must first be loosened before any collimation adjustments can be made to the primary mirror.

To start, loosen the locking thumbscrews a few turns each. Now, try tightening or loosening one of the larger collimation thumbscrews with your fingers. Look into the focuser and see

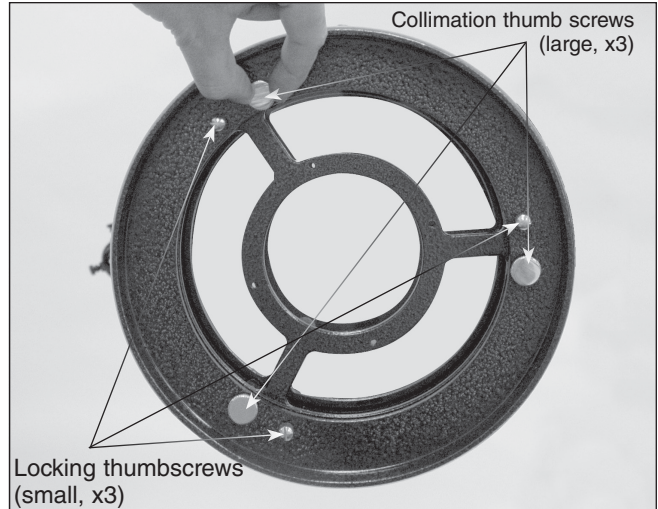

Figure 5. The three small thumbscrews that lock the primary mirror in place must first be loosened before any adjustments can be made. Then the tilt of the primary mirror can be adjusted by turning one or more of the three larger thumbscrews.

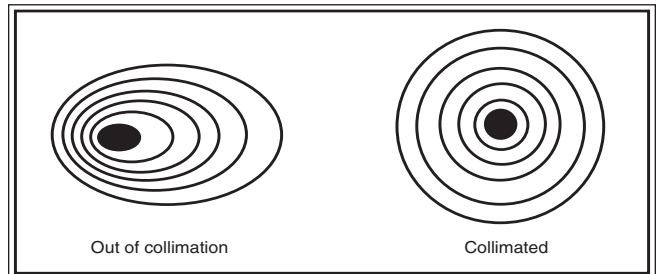

Figure 6. A star test will determine if a telescope's optics are properly collimated. An unfocused view of a bright star through the eyepiece should appear as illustrated on the right if the optics are perfectly collimated. If the circle is unsymmetrical, as on the left, the scope needs further collimation.

if the secondary mirror reflection has moved closer to the center of the primary. You can tell this easily with the collimation cap and mirror center mark by simply watching to see if the “dot” of the collimation cap is moving closer or farther away from the ring on the center of the primary mirror. If the dot moved farther away from the ring, try turning the thumbscrew the opposite way, or try turning a different collimation thumbscrew and seeing what happens. When you have the dot centered as much as possible in the ring, your primary mirror is collimated. The view through the collimation cap should now resemble **Figure 2e**. Retighten the locking thumbscrews.

The true test of whether your telescope's optics are accurately collimated is a star test. Here's how to do it.

Star-Testing the Telescope

When it is dark, point the telescope at a bright star and accurately center it in the eyepiece's field of view. Slowly de-focus the image with the focusing knob. If the telescope is correctly collimated, the expanding disk should be a perfect circle (**Figure 6, right**). The dark shadow cast by the secondary mirror should appear in the very center of the out-of-focus circle,

like the hole in a donut. If the circle is distorted and the dark “hole” appears off-center, the telescope is out of collimation (**Figure 6, left**) and you’ll need to go through the collimation process again.

If you try the star test and the bright star you have selected is not accurately centered in the eyepiece, the optics will always appear out of collimation, even though they may be perfectly aligned. It is critical to keep the star centered, so during the test you may need to make slight corrections to the telescope’s position to bring the star back to the center of the field of view. A good star to point at for a star test, for northern hemisphere observers, is Polaris, the North Star, because its position does not move significantly over time.

A Great Optional Accessory

A laser collimator such as the Orion LaserMate Deluxe II makes collimating a reflector telescope’s optics quick, easy, and very precise. Check it out at our website, www.Telescope.com.

One-Year Limited Warranty

This Orion product is warranted against defects in materials or workmanship for a period of one year from the date of purchase. This warranty is for the benefit of the original retail purchaser only. During this warranty period Orion Telescopes & Binoculars will repair or replace, at Orion’s option, any warranted instrument that proves to be defective, provided it is returned postage paid. Proof of purchase (such as a copy of the original receipt) is required. This warranty is only valid in the country of purchase.

This warranty does not apply if, in Orion’s judgment, the instrument has been abused, mishandled, or modified, nor does it apply to normal wear and tear. This warranty gives you specific legal rights. It is not intended to remove or restrict your other legal rights under applicable local consumer law; your state or national statutory consumer rights governing the sale of consumer goods remain fully applicable.

For further warranty information, please visit www.OrionTelescopes.com/warranty.



Corporate Offices: 89 Hangar Way, Watsonville CA 95076 - USA
Toll Free USA & Canada: (800) 447-1001
International: +1(831) 763-7000
Customer Support: support@telescope.com